





Feedback of 1° grade English test

Name: _____

Date: September 28th

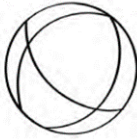
- I- En la primera parte de tu evaluación escribiste el nombre de los juguetes de esta forma.

	
Ball	Car

Now you!

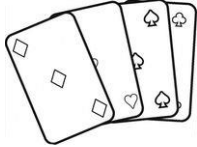
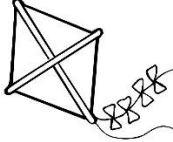
- II- En la segunda parte leíste las palabras y elegiste la correcta respecto al dibujo.



Car	Bus
-----	-----

Now you!







puzzle	Computer game
--------	---------------

III- En la tercera parte tus respuestas deben ser completas de esta forma:



What is this?  This is a plane

Now you!





1- What is this?  _____	2- What is this?  _____
--	--

3- What is this?  _____	4- What is this?  _____
--	--

IV- En nuestra última parte debemos responder con respuesta corta de esta forma:

<p>Have you got a ball?</p>  <p>Yes, I have</p>	<p>Have you got a car?</p>  <p>No, I haven't</p>
--	---

Now you!

<p>1- Have you got a car?</p>  <hr/>	<p>2- Have you got a robot?</p>  <hr/>
<p>3- Have you got a yoyo?</p>  <hr/>	<p>4- Have you got a teddy?</p>  <hr/>

